

Control & Instrumentation

Control & Instrumentation

Analogue & Digital Servo Trainer

Modular Servo System

Transducers kit

Programmable logic control applications

Dual Conveyor PLC Workcell

Elevator

Digital Pendulum control system

Magnetic levitation

Twin rotor MIMO system

Modular servo control workshop

Coupled tanks system

Control engineering enables engineers to use mathematical models to predict, understand and ultimately create systems which will follow precise tasks or operations according to a command or feedback.

Control engineering essentially allows machines to operate independently. Without it, machines would need constant human intervention, whether it be an aircraft or a manufacturing plant.



This trainer allows the investigation of control system principles by using a servo mechanism comprising a d.c. motor, a variety of sensors and both analogue and digital controllers. Students are also introduced to the fundamentals of transducers and signal processing.

The supplied Espial student courseware is divided into twenty four assignments ranging from basic control concepts to more advanced topics such as transfer function analysis. Selective use of the assignments allows the trainer to be used from vocational through to higher technician and undergraduate courses.

Subject Areas

- Operational amplifiers
- Analogue transducers
- Positive and negative feedback
- Gain and stability
- Closed loop position and speed control
- PID control
- Feed-forward systems
- Analogue to digital conversion
- Digital speed and position measurement
- Absolute and incremental encoders
- Digital controllers
- Motor and eddy current brake characteristics
- Transfer function analysis
- Open and closed loop transfer functions

Features

- Teaches the concepts of control, sensors and signal processing
- Real mechanical plant
- Suitable for teaching both theory and practice
- Contains both analogue and digital controllers
- Compares digital and analogue sensors
- Digital controller uses an embedded processor
- Linear and PWM motor drive
- On-board sine, square and triangle wave generator
- Espial software with built-in instrumentation
- Open and closed loop transfer functions with Bode and Nyquist displays
- Complete workstation including power supply

TK2942

Transducers Kit

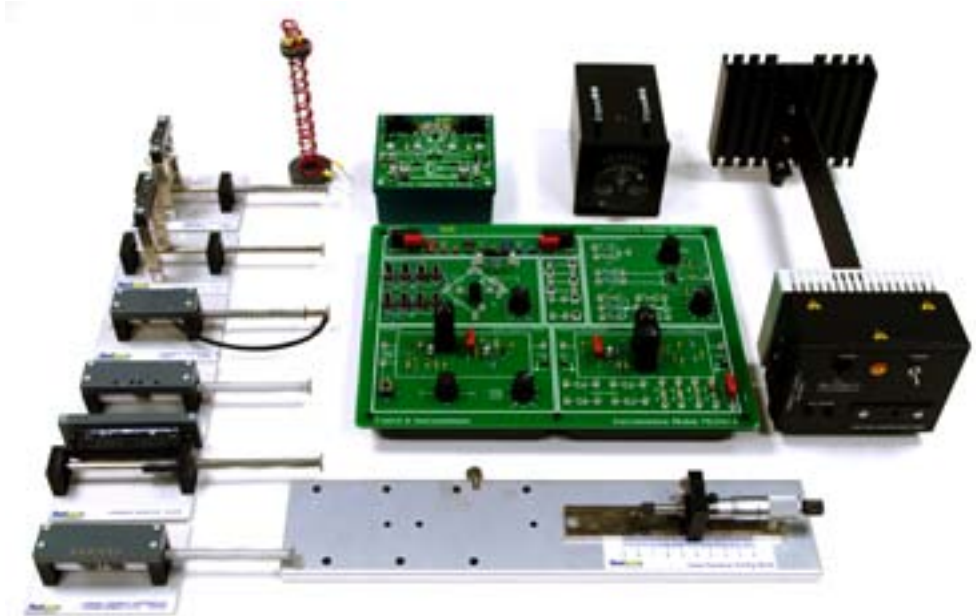

Features

- Bench-top study of transducer applications
- 28 student experiments
- Text covers theory, practice and industrial applications
- Employs 14 common industrial transducers
- Inclusive a.c. and d.c. instrumentation sections
- Suitable for most engineering disciplines

The Transducers Kit TK2942 covers a wide range of transducers and a number of standard signal processing methods. The range consists of a measurements package, containing a comprehensive instrumentation module, a power amplifier and a test rig, plus three self-contained Transducers Kits.

Subject Areas

- Electro-mechanical transducers
- Light transducers
- Heat transducers
- The Wheatstone Bridge
- Liquid depth and resistivity
- Heat distribution
- Temperature control
- Photoconductive cell
- Spectral response

The kits are available separately, allowing complete transducer workstations to be built-up in stages. Electro-mechanical Transducers Kit TK2941E comprises six linear displacement transducers. It is the foundation kit for the TK2942 range and introduces some basic principles about transducers and the associated instrumentation requirements. The two other kits should be regarded as extensions to it.



Imagine throwing a ball onto a plate and it being stabilised exactly in the centre within two seconds. The remarkable response of this control system is due to the implementation of advanced control techniques which are now prevalent in modern industrial processes. Feedback Instrument's Ball and Plate control system demonstrates a classic control problem of balancing a sphere on a flat surface and maintaining its position. It can then be programmed to make the ball describe a circular or any other shaped path around the plate.

Subject Areas

- Enables study of real-time control of a non-linear and unstable process
- Implementation of digital control techniques using NI LabVIEW
- Ball position sensing and image processing using USB camera
- Open and closed loop configurations
- Suitable for undergraduate courses in electrical, electronic and mechanical engineering
- Non-linear model testing
- Ball and Plate setup control
- Real-time PID control of ball position
- Real-time trajectory tracking with ball

The unique electromagnetic table actuation enables the study of this unstable system in real-time using sophisticated controllers in NI LabVIEW. The progressive nature of the student exercises enables the study of the problem from first principles to more advanced control concepts. The product provides a useful insight into control engineering at all levels of undergraduate study and enables advanced users to model and control the Ball and Plate using their own strategy.

Features

- Intriguing control experiment with extensive student courseware
- Progressive student exercises
- Suitable for teaching theory and practice
- Real mechanical plant
- Contains both analogue and digital controllers



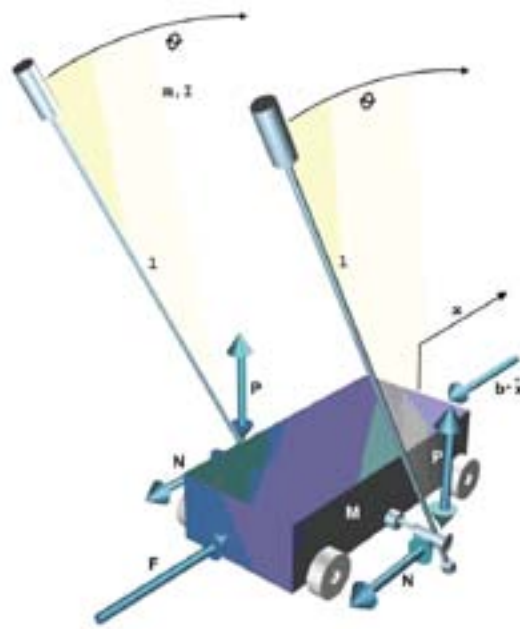

MATLAB is a higher level technical computing language that provides an environment for algorithm development, data analysis, data visualization, etc. Together with Simulink and additional toolboxes it facilitates control system design and analysis, which can later be implemented in real-time applications using Real-time workshop. With an Advantech PCI card this creates an impressive digital control system development environment.

Feedback Instruments control applications are designed to be compatible with such an environment. Using the detailed training manuals the user is guided through the design process within MATLAB.

The Phenomenological process models are designed in Simulink to provide initial models for the user to test. Model linearization is then discussed and this use of simple dynamics analysis - like bode diagrams poles and zeros maps are introduced.

To obtain accurate models identification procedures incorporating MATLAB functions are described. The user has a chance to go step-by-step through the discrete models identification.

One of the obtained models is used for the controllers design and PID control is explained. A guide is given for PID controller design, testing, tuning and implementation on the model. Root locus technique is used to illustrate the changes that PID controller tuning on the control system performance.

The designated controllers are prepared in Simulink to be built and tested through the Real-time workshop using the Feedback Control applications.

The series of assignments provide a comprehensive course and the user has a choice of using the pre-written applications, according to the manual, or designing their own.

The following development steps are described:

- Phenomenological process models
- Dynamics analysis
- Discrete models identification
- Controller Design
- Controller tests on the model
- Controller implementation in real-time applications
- Implementation of various control strategies
- Data visualisation

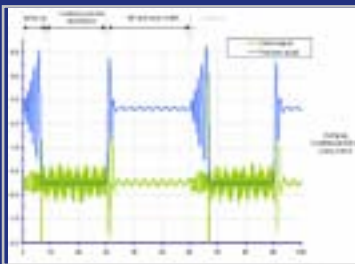

Plot showing comparison between pendulum angle and corresponding control signal

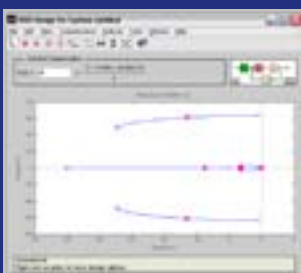

Example of a Self-designed control system



The **MS150 Modular Servo System** is designed to study the theory and practice of automatic control systems. It has been designed for teaching the theory of open and closed-loop, speed and positional control systems using modular units, both mechanical and electronic, that can be configured to demonstrate the various methods of control techniques. Derivatives of this product have been used in technical institutes and training establishments throughout the world for many years.

The MS150 is available as an a.c. only or d.c. only system, a combined system or, as a digital system in a MATLAB[®] environment. Conversion sets to enable a change from one system to another are available.

The modular concept of the MS150 system permits the study of individual units and also, by combination, the investigation and performance testing of complete systems. A series of instructional manuals are supplied to provide comprehensive coverage of servo system theory and assignments for a wide range of student abilities.

Subject Area

- Operational Amplifiers
- Motor Speed Characteristics
- Simple Position Control
- Closed-Loop Position Control
- Simple Speed Control
- Deadband and Step Response
- Velocity Feedback
- Analysis of Simple Position Control

Features

- Modular, versatile system
- Rugged construction
- Extendable and upgradable
- Option to use with MATLAB
- 'Hands-on' assembling of working systems
- In-built protection against incorrect connection and short circuits
- Easily extended to cover digital systems



33-005

Digital Pendulum System

Features

- Dual mode system - crane or inverted pendulum
- Self-erecting pendulum mode
- Extensive MATLAB toolboxes are available from The MathWorks Inc.
- An ideal vehicle for both laboratory and project work

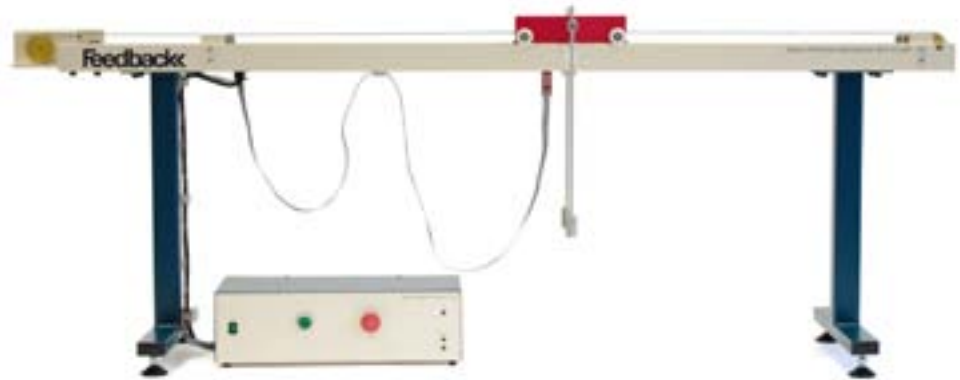

The Digital Pendulum is a modern version of a classical control problem; that of erecting and balancing a free swinging pendulum in its inverted position or moving a hanging pendulum in a controlled manner.

The cart on the track is digitally controlled to swing up and to balance the pendulum into an upright sustained position or to move the cart with pendulum in an unperturbed down position.

The cart track is of limited length, imposing constraints on the control algorithm. In pendulum mode the system is used to control the twin arm pendulum from an initial position, hanging at rest with the cart in the centre of its travel along the track, to a final position with the pendulum upright and the cart restored to its central position. In crane mode the control problem is to move the position of the cart without undue movement of the pendulum.

Subject Areas

- Utilisation of MATLAB System Identification Toolbox
- Crane Linear Model Identification
- Inverted Pendulum Linear Model
- Pendulum Set-Up Control
- PID Control of Cart Model
- Real-Time PID Control of Cart Position
- Real-Time Swing-Up Control
- Inverted Pendulum Control and Stabilisation
- Combined Control Techniques
- Pendulum Model
- Equations of Motion



This classic magnetic levitation control problem is now presented in a new and innovative form. A 25 mm diameter, hollow steel sphere is suspended in space with visually appealing results and convenient time constants.

Both analogue & digital control solutions are implemented. Convenient sockets on the enclosure panel allow for quick changes of analogue controller gain and compensation components.

Subject Areas

- Analogue and digital control methods
- Closed loop control
- Real time digital control
- Linearization of non-linear system
- Conversion methods
- Closed loop PID control
- Sample time & effects

The equipment is self-contained in analogue mode, with built-in power supply. In the digital mode the system operates within a MATLAB environment which allows the system parameters to be determined and the system to be modelled. Once the digital controller parameters have been determined, the controller can be used to run the hardware and the actual control performance can be seen and analysed.

Features

- Fully compatible with MATLAB
- Integrated power supply
- Self-contained bench top unit
- Infra-red sensor characteristics
- Lead-lag compensation
- Perturbation sensitivity
- Non-linear model
- Unstable system
- Linearization about an operating point
- A/D and D/A conversion
- Closed-loop identification
- State space PD control
- Regulation and tracking control





Features

- Classic multivariable system
- MATLAB software environment
- Dynamics analysis
- Discrete models identification
- Controller design, test and implementation in real-time applications
- Implementation of various control strategies
- Non-linear processes
- Closed loop identification

The Twin Rotor System

demonstrates the principles of a non-linear, multiple input multiple output (MIMO) system with significant cross-coupling. Its behaviour resembles a helicopter but the angle of attack of the rotors is fixed and the aerodynamic forces are controlled by varying the speeds of the motors.

Significant cross-coupling is observed between the actions of the rotors, with each rotor influencing both angle positions. The MATLAB software allows the student to design and test stabilising controllers with independent control applied to each coordinate of the system.

Subject Area

- 1-Degree of Freedom (DOF)
- PID stabilising and tracking
- Horizontal controller
- 1-DOF PID stabilising and tracking vertical controller with gravity compensation
- 2-DOF PID stabilising and tracking controller
- Parameter tuning
- Coupled dynamics analysis
- Dynamics decoupling
- Phenomenology analysis
- Model identification

More advanced investigations may be carried out through user-defined algorithms from within SIMULINK.



The Precision Modular Servo Workshop has been designed to give a rapid and direct path from control system design to hardware implementation. The resolution and accuracy of the system, and the consistency of its performance, makes the Precision Modular Servo Workshop ideal for serious study of digital linear servo control systems.

As well as allowing study of digital control the Precision Modular Servo Workshop also provides a complete introduction to servos, from fundamental studies of analogue servos through to full, real-time digital control using MATLAB, SIMULINK, Real-time Workshop and Real-time Windows Target.

It is fully supported with laboratory assignments which have been designed to give students a full understanding of the control paths within the equipment.

Subject Areas

- Precision Modular Servo (PMS)
- Testing the d.c. motor model
- PMS model identification
- PMS set-up control
- Plant control
- PMS position control
- PMS control under variable load conditions

For customers who would like to upgrade their existing MS150 system to be used with MATLAB software (33-008), there is an upgrade pack 33-310-PCI available.

Features

- Analogue servo operation
- Open-loop systems Speed/Position
- Closed-loop systems Speed/Position
- Motor characteristics
- Frequency and Step response measurements
- Digital servo operation
- Real-time digital control
- PID controller design
- Adaptive control

33-041/33-042

Coupled Tanks Systems



The Coupled Tanks set-up is a model of a chemical plant fragment. Often tanks are coupled through pipes and the reactant level and flow has to be controlled. The Coupled Tanks experiment is designed so that the system can be configured.

The Coupled Tanks system has four translucent tanks each with a pressure sensor to measure the water level. The couplings between the tanks can be modified by the use of seven manual valves to change the dynamics of the system imposing the use of different controllers.

The product is supplied with comprehensive student manuals that provide information about the physical behaviour of the system models and guide the student through the control tasks. Control algorithms are developed, tested on the models and then implemented in a real-time application.



Subject Areas

- Nonlinear model
- Linearisation and linear model simulation
- 1 tank and 2 tank model identification
- PID control of water level in top tanks
- PID control of water level in bottom tanks
- Parallel PID control in two double tank columns
- Cross-coupling introduction and analysis
- Dynamics decoupling with cross-coupling identification
- PID control with decoupling
- Disturbance compensator with PID control

Features

- Fully compatible with MATLAB and SIMULINK or NI LabVIEW
- Self-contained unit can be either floor or bench mounted
- Four tanks each with pressure-sensor water level measurement and easy-to-read visual scale
- Two independently controlled pumps allow variable flow control
- Easy to configure coupling between tanks allows for a wide range of control scenarios from basic to advanced level
- Can be configured as Single Input, Single Output (SISO) or Multiple Input, Multiple Output (MIMO) system
- System dynamics can be modified using easy to change orifice caps

Programmable Logic Control Applications

Complete integrated range

Low cost start up with 34-501/502

Mitsubishi, Siemens & Allen Bradley PLC options

Programming examples provided

PLC Trainer Curriculum relevant to BTEC Syllabuses

External connection highway by D type connector leads

Progressive Student Exercises

Programmable Logic Controllers (PLCs) are used extensively in many manufacturing processes and control applications being readily programmed and reprogrammed when variations in the controlled process are required.

The Feedback PLC Trainer and PLC Applications offer extensive training in basic PLC structure, identifying types of input and output options and programming from simple to more advanced routines including Ethernet communications.

The Feedback range of PLC products offers a choice in both cost and complexity such that those with little or no knowledge can start with the PLC Trainer and progress through to complex systems with their more challenging programming requirements.

All applications in this range are readily interchangeable (Plug and Play) through the use of plug leads once the PLC has been configured.

In the case of the PLC Trainer, the PLC hardware structure allows for expansion of the core digital unit with the addition of analogue modules and the option of a Human Machine Interface (HMI) over Ethernet. This extends the learning into the programming and application of such devices.

The Feedback trainers are supported with a user manual, program examples and solutions. The subject coverage of the PLC Trainer is particularly relevant to the curriculum requirements of BTEC National NQF Level 3 and BTEC Higher National - H1 NQF Level 4.



Features

- Specifically designed for those with little or no knowledge of PLCs
- Large number of exercises covered from the basics to more complex applications
- 14 areas of components to study
- Programming examples provided
- External connections by D type connector leads
- On board connections by 2mm plug leads
- Content relevant to BTEC National NQF Level 3 and BTEC Higher National -H1 NQF Level 4
- Extensions to Analogue I/O and HMI

The Feedback PLC Trainer offers the training required to understand and apply both PLC hardware and software programming through the structured students manual that provides a progressive level of learning.

The manual deals with the fundamentals of PLC hardware and software through to basic program writing and more advanced applications, finally to motor control.

The PLC Trainer is an A3 size board that is divided into many individual smaller areas. Each one of these areas contains a number of components that are described and applied to gain an appreciation of their application.

Subject Areas

- Down loading and up loading programs
- Selecting inputs & outputs & data processing
- Implementing simple instructions
- Logic functions AND, OR, inverse
- Understanding Flags
- Understanding registers & using timers and counters
- Writing program to operate devices & control processes
- Simple logic configurations with LED output
- Input from a code switch to internal counter value and seven segment display LED
- LED Traffic light sequencing, single, dual ways (Cross roads)
- Stepper motor position to desired point & home position
- Stepper motor drive sequencing also with counter & display
- d.c. Motor speed PWM control

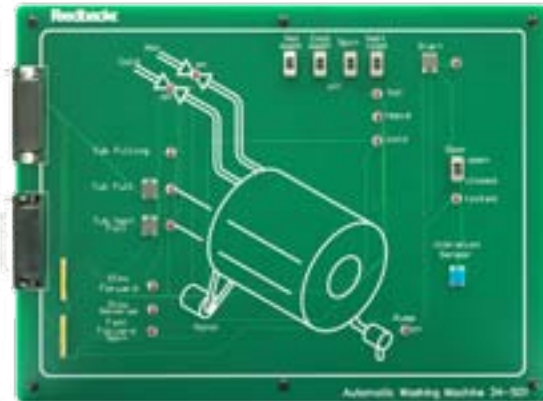

The Feedback **34-501 washing machine** and **34-502 traffic light PLC applications** provide students with a hands-on resource for learning PLC fundamentals.

The automatic washing machine's initial program conditions can be set by switched selection. this allows the development of several different programs that can be used as conditional jumps, depending on how the initial conditions have been

set. Using push-button switches to simulate interrupt conditions, such as unbalanced drum load, more complex control problems can be developed.

Washing Machine Features

- Demonstrates sequential control
- Initial process conditions can be set
- Demonstrates the use of simple interrupts
- Low cost
- Fundamentals of logic
- Basics of PLC programming
- Developing Ladder Logic Programs
- Programming timers

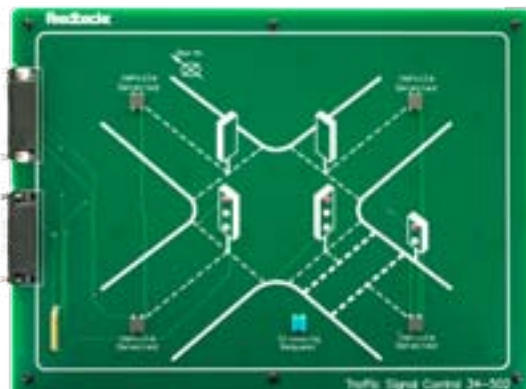

The traffic light system's simple sequence application allows control of a crossroads to be implemented on a time sequence basis. The control program can be further developed to cope with interrupts generated from pedestrian crossing requests or off-peak vehicle detector inputs.

Traffic Signal Control Features

- Timed sequence control
- Interrupt device control
- Easy to understand process
- Low cost
- Programming counters
- Setting initial conditions
- Time based process control
- Use of interrupts and emergency stop

34-120 SYSTEM

Dual Conveyor Workcell

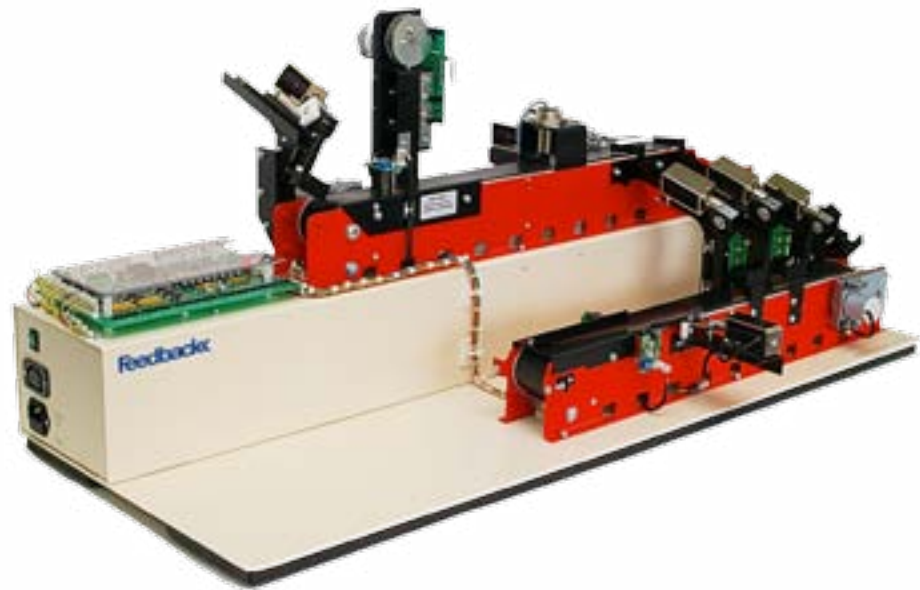

Features

- Part selection by logical detection
- Induction and opto-electronic sensors
- Component sort and assembly process
- Interfaces to most major PLC types
- Comprehensive courseware manual

The added complexity of this dual conveyor system allows greater study of PLCs in process control systems. More complex control scenarios can be developed using combinations of timers and counters with master and zone control functions.

The self-contained unit comprises a power supply, interface board and a range of sensors and solenoid actuators, including a height gauging unit. The interface circuits allow the conveyor system to be operated from any standard industrial PLC using 24 V d.c. logic levels.

There are connections provided on the interface board to drive an optional diameter gauging unit. The addition of the second gauge unit to measure component diameter allows programs of greater complexity to be developed. The programming of the component detector is an excellent introduction to the use of logical detectors for in-process inspection and quality control.

Subject Areas

- Fundamentals of logic
- Basics of PLC programming
- Developing ladder logic programs
- Programming timers
- Programming counters
- Structure of control systems
- Sequencer programs
- Jump instructions and subroutines
- Combined counter and timer functions
- PLC Installation Practices

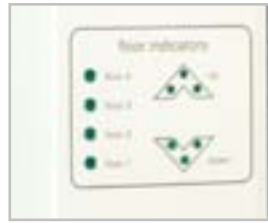

The elevator provides a sophisticated application to illustrate the principles of PLC interfacing & control based on a real-life application. Starting with simple program sequences to control elevator speed, direction and floor arrival/departure, the student can progress to advanced floor request handling and continuous (analogue) control with acceleration profiling and compensation for varying car loads.

The internal motor speed controller has both logic and analogue interfaces such that a basic PLC with minimal digital I/O can be used to implement control. More sophisticated control may be developed if analogue I/O is available.

The load-cell and motor position feedback signals are available to develop programs for continuous control. The load-cell indicates elevator car loading and a set of weights simulates varying numbers of car occupants. The position feedback signal allows for the development possibility of advanced control of the elevator car motion.

Features

- Fully working model of an elevator with four floors
- Floor sensing and visual indication of direction of travel
- Motorised elevator car door
- Normally 'on' brake to hold car at desired floor
- Up/down call buttons on each floor
- Front panel manual switch for testing and debugging
- Integral motor servo controller
- Interfaces with most PLC types. Analogue outputs and inputs are also available
- Switchable faults
- Fundamentals of logic
- Basics of PLC programming
- Developing ladder logic programs
- Basic and advanced sequence control

34 Series Digital PLC Product Range

(with analogue and HMI options)

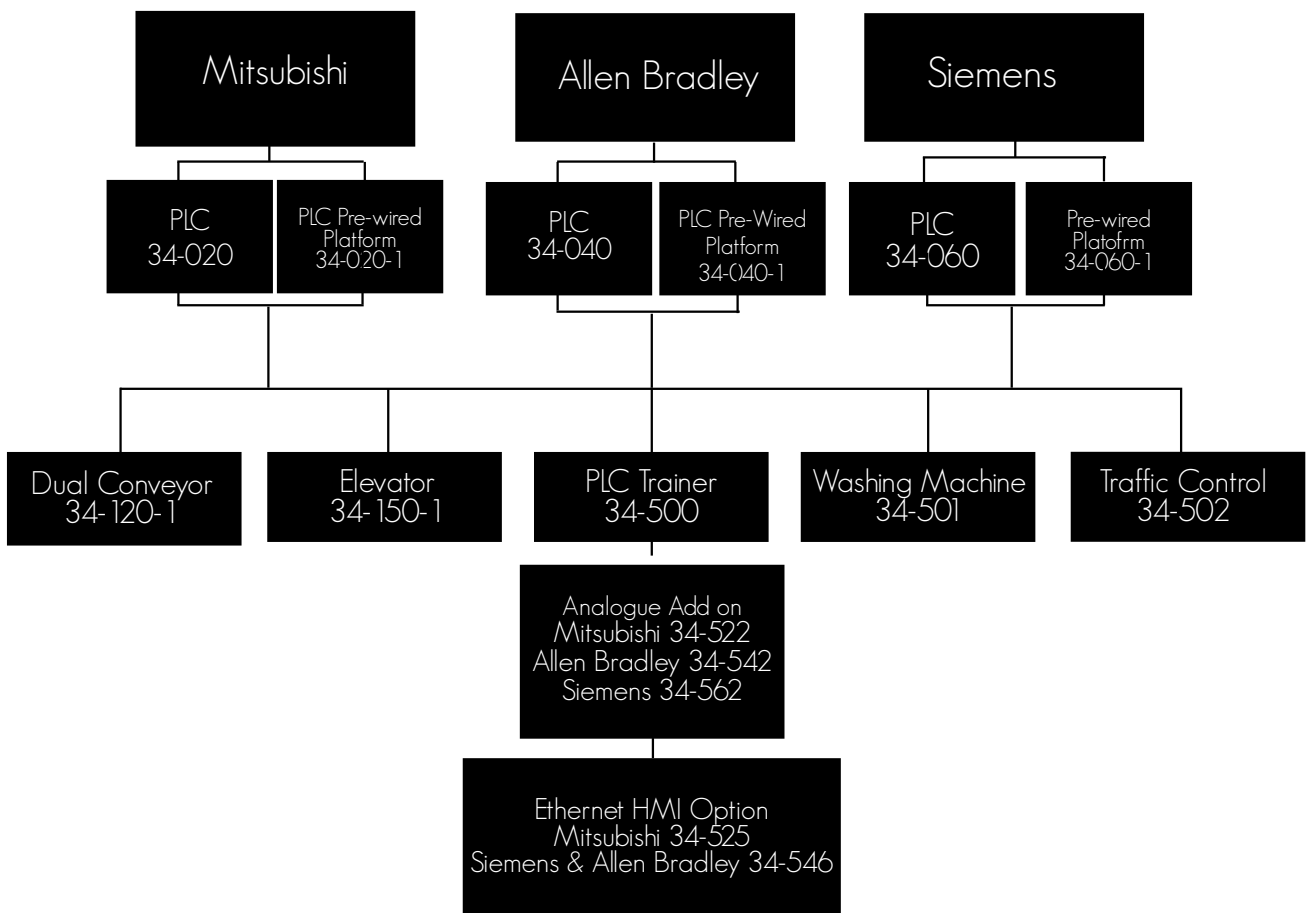



For more information about
any of the products that you see
in this catalogue, please contact us:

www.feedback-instruments.com
feedback@feedback-instruments.com

Feedback Instruments Ltd.
5 & 6 Warren Court, Park Road,
Crowborough,
East Sussex,
England, TN6 2QX
Tel: +44 1892 653322
Fax: +44 1892 663719

Feedback Inc.
437 Dimmocks Mill Road,
Suite 27
Hillsborough
NC 27278, USA
Tel: 919 644 6466
Fax: 919 644 6470

Feedback Instruments Catalogue - Version 2013
Registered in England. Number 08078112
A subsidiary of LD Didactic GmbH

